

• Body Shop Curtains • Wash Bay Curtains • Prep Area Curtains • Estimating Bays •



# Custom Curtain Walls

## Custom Auto Body & Collision Repair Curtains!

### Ideal For:

- Paint, Primer, & Prep Areas
- Under Coat Bays
- Metal Shops
- Estimating Bays
- Wash Bays
- Grinding Areas
- Welding Areas
- Sanding Areas
- Parts Edging Areas
- And More!



**#1**  
**Manufacturer**  
**of Body Shop**  
**Curtains!**



*Curtains Easily Glide In & Out of Use When Needed to Separate Conflicting Tasks/Work Environments.*



**Goff's is the #1 Manufacturer of Curtain Walls for the O.E.M. Prep-Station Industry!**

• Body Shop Curtains • Wash Bay Curtains • Prep Area Curtains • Estimating Bays •

Let us do the work for you!

## Features & Benefits

### Benefits of Goff's Curtain Walls

- A safer work environment
- Increased productivity and improved working conditions
- Confinement of contaminants
- Protection from sparks and hazardous debris
- Improved facility appearance
- Fast Delivery

### Features Include:

- 14 oz. vinyl coated polyester fabric with 20 mil. clear PVC window section
- Curtains meet NFPA 701 & California State Fire Marshal Standards
- Double Lock Stitching with mildew/rot resistant thread
- Finished Edges with 2" Industrial Strength Velcro for attaching to adjacent curtains
- Fully enclosed, sewn in, galvanized chain in the bottom hem for motion reduction
- Resistant to most chemicals
- Easy to install, clean and replace
- Eliminates costly brick and mortar permanent type walls



## Materials, Construction & Sizes

### Goff's Curtain Walls are Custom Made for each Application.

Curtains can be made in any length up to 100' high and in any layout.



#### 14oz Vinyl Color Options



**Ordering your custom product is easier than ever!**

## Mounting Hardware

### Goff's Curtains come complete with mounting hardware!

For smooth, easy movement all curtain systems come complete with a heavy duty 16 gauge galvanized steel track and roller hook system.

Goff's unique Universal Track Splice allows for suspend, face, or flush mounting. Goff's will send you the proper assortment of hardware for your dimensions and layout.

**Floor Mount Hardware Also Available!** All hardware carries a limited lifetime warranty. For a complete list of hardware please visit [www.goffscurtainwalls.com/curtain-walls/curtain-wall-hardware](http://www.goffscurtainwalls.com/curtain-walls/curtain-wall-hardware)

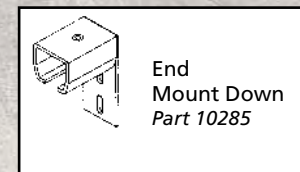
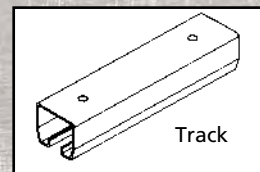
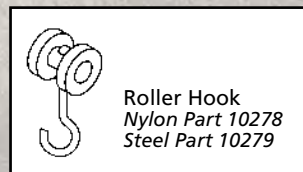
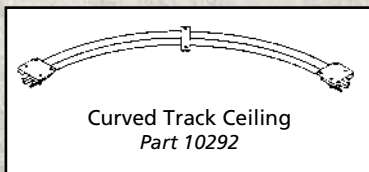
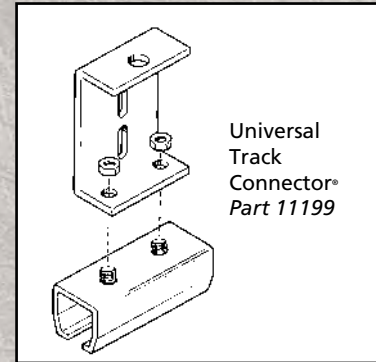

## Options & Accessories

### Goff's Curtain Walls can be equipped with a number of accessories and add-on's

**Floor Mount Wind Ties** – Easy to fasten tie downs are sewn directly onto the bottom of the Curtain. Available in 2 models.

**Filter Panels** – Easily removable and replaceable in 2 sizes: 2' x 4' or 4' x 4'. Filter sections are reinforced via a nylon scrim pattern.

**Strip Door** – 3' wide x 7' high replaceable strip door sewn directly into the curtain

**Valance Panels** – Stationary custom vinyl pieces manufactured to any size to seal area above the curtain. Perfect for slanted ceilings.

**Floor Sweep Attachment** – 6" replaceable vinyl piece to seal the gap between the Curtain Wall's bottom and the floor. Perfect for pitched floors.

**Curtain Wall Cleaner & Shield** – Shield All provides a semi-transparent, protective coating. Cleaner is a safe and effective way to clean the entire Curtain Wall without damaging the vinyl.

**Steel Rollers** – Recommended for curtains over 16' high

**Vinyl Mesh** – 11 oz. 17x11 Mesh Scrim Available for improved airflow.

**Custom Logos** – Personalize your curtain with your company logo or slogan. Custom priced based on size, colors and quantity.



• Body Shop Curtains • Wash Bay Curtains • Prep Area Curtains • Estimating Bays •

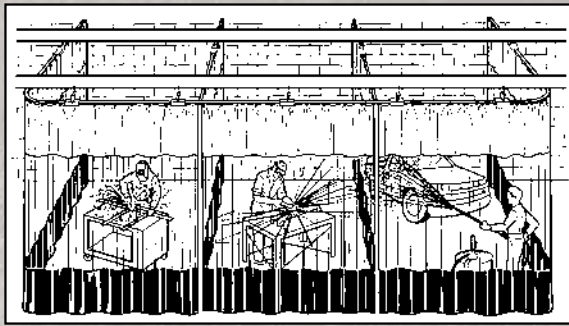

Single Curtains or Multi-Sided Stations

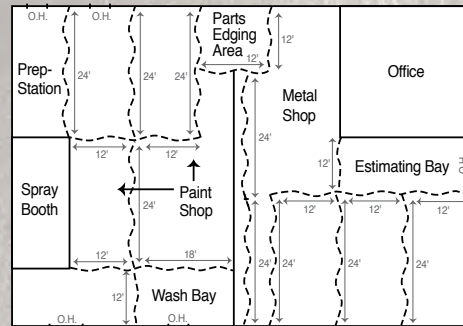

Body Shop Layout Example

## Stock Curtains

**Goff's also has Stock Sizes available ready to ship within 24 Hours!**

Stock Curtains are available in 6', 12', and 24' wide sections and available in 8', 9', 10', and 12' heights and come complete with mounting hardware.

Stock Curtains come standard with a white vinyl top, clear middle window, and blue vinyl bottom.

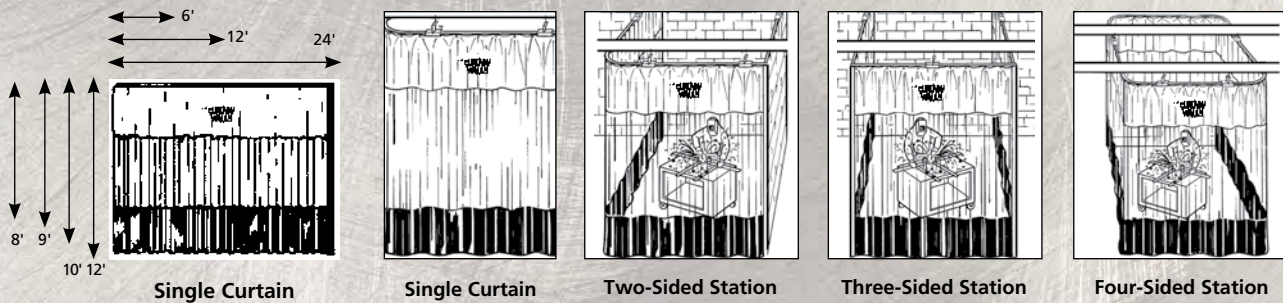

**Warranty:** Goff's warrants all curtain wall systems from failure in normal use due to defects in material or workmanship for a period of five years from date of purchase. Lifetime warranty on all track and roller hardware. Goff's Enterprises, Inc. may elect to repair or replace defective or damaged goods.

## Goff's Other Products

**Goff's Product line includes a variety of custom made vinyl products.**

Other products include High Performance Vinyl & Mesh Doors, Roll-up Curtains, Outdoor & Super Exterior Curtains, Climate Control Curtains, Welding Curtains, Strip Doors, Welding Screens, Privacy Screens, Noise Control Curtains & Screens, Trailer Doors, Manual Bug Blocking Doors, Food Processing Curtains, & More!



Distributed By

6/13



700 Hickory Street • Pewaukee, WI 53072  
 Phone: (262) 691-4998 • 800-234-0337  
 Fax: (262) 691-3255 • 800-959-0170  
[www.GoffsCurtainWalls.com](http://www.GoffsCurtainWalls.com)  
[sales@goffscw.com](mailto:sales@goffscw.com)  
[Facebook.com/GoffsEnterprises](https://www.facebook.com/GoffsEnterprises)  
[Twitter.com/GoffsEnt](https://twitter.com/GoffsEnt)



Made in U.S.A.

# Goff's **CLEAN CURTAINS**

## **Food Processing Clean Curtains**

### **Sanitation Through Separation**



- ✓ Reduce Process Line Downtime
- ✓ Improve Plant Sanitation
- ✓ Prevent Cross Contamination Between Processing Lines
- ✓ Turn Sanitation Hours into Production Hours

*Goff's Clean Curtains are custom made to any dimensions and layout!*

#### **Curtains**

- Curtains are constructed with a Heavy Duty 40 Mil double polished Clear USDA Grade PVC
- Material is non-porous and sheds water, solutions, and soils easily
- Rolled rimmed stainless steel grommets with spur washer on 12" centers
- Heat-sealed vertical seams prevent trapping of contaminants
- 6" overlap between curtain panels to prevent wash break through

#### **Hardware**

- Stainless Steel Track and Trolley Hardware System
- Open Trolley design to prevent bacteria from forming
- 2 Hardware Types available depending on usage (*see reverse side*)



## Standard Stainless Hardware

- 304 Stainless Steel
- 1.25" Diameter Roller Tube
- 0.65 Wall Thickness
- Formed Stainless Steel with Delrin Ball Rollers and Integrated Hook



### Mounting

Goff's stainless hardware can be mounted 2 ways - Suspend or Angle Suspend. Please specify when ordering to receive proper brackets.



Suspend Mount

Angle Suspend Mount

## Electropolish Upgrade

Goff's Stainless Steel Hardware comes standard unpolished. An Electropolish upgrade is available.

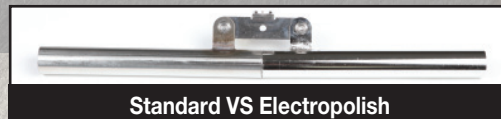

Standard VS Electropolish

## Heavy Duty Stainless Steel Hardware (Upgrade)

- 304 Stainless Steel
- 3.5" Tall Track Flange for ease of installation
- 1-5/8" Diameter Roller Tube
- Delrin Rollers with Stainless Steel Bushings and Stamped Stainless Roller Saddle and Swivel Hook. Heavy Duty Track comes standard polished.



*Goff's also offers non-stainless (galvanized steel) style hardware.*

**Warranty:** Goff's Enterprises, Inc. warrants all Curtain Wall Systems from failure in normal use due to defects in material or workmanship for a period of FIVE years from date of purchase. A LIFETIME warranty on all stainless track & roller hardware. Goff's Enterprises may elect to repair or replace defective or damaged goods.

**Please be Advised:** Goff's 40 Mil USDA PVC is authorized for indirect food contact without restriction (ref. FDA 21 CFR). It may be safely used for contact with food; however, it may not be used as a food additive, which would be termed "direct". All components used in the manufacture of the material are sanctioned by the U.S. FDA for food applications under Title 21 part 174-182 of the Code of Federal Regulations.

## Goff's Other Products

**Goff's Product line includes a variety of custom made vinyl products.**

Other products include High Performance Vinyl & Mesh Doors, Roll-up Curtains, Outdoor & Super Exterior Curtains, Climate Control Curtains, Welding Curtains, Strip Doors, Welding Screens, Privacy Screens, Noise Control Curtains & Screens, Trailer Doors, Manual Bug Blocking Doors, Food Processing Curtains, & More!



Distributed By

5/13



700 Hickory Street • Pewaukee, WI 53072

Phone: (262) 691-4998 • 800-234-0337

Fax: (262) 691-3255 • 800-959-0170

[www.GoffsCurtainWalls.com](http://www.GoffsCurtainWalls.com)

[sales@goffscw.com](mailto:sales@goffscw.com)

[Facebook.com/GoffsEnterprises](https://www.facebook.com/GoffsEnterprises)

[Twitter.com/GoffsEnt](https://twitter.com/GoffsEnt)



Made in U.S.A.



*Let us do the work for you!*

## Features & Benefits

### Benefits of Goff's Curtain Walls

#### Include:

- Separates conflicting tasks/work environments
- Quickly creates privacy areas
- Improves working conditions
- Easily slides out of the way when not needed
- Helps to control contaminants, temperature, odors, sound and light
- Fast Delivery!

#### Features Include:

- 14 oz. vinyl coated polyester fabric with 20 mil. clear PVC window section
- Curtains meet NFPA 701 & California State Fire Marshal Standards
- Double Lock Stitching with mildew/rot resistant thread
- Finished Edges with 2" Industrial Strength Velcro for attaching to adjacent curtains
- Fully enclosed, sewn in, galvanized chain in the bottom hem for motion reduction
- Resistant to most chemicals
- Easy to install, clean and replace
- Eliminates costly brick and mortar permanent type walls



## Materials, Construction & Sizes

### Goff's Curtain Walls are Custom Made for each Application.

Curtains can be made in any length up to 100' high and in any layout.



#### 14oz Vinyl Color Options





**Ordering your custom product is easier than ever!**

## Mounting Hardware

### Goff's Curtains come complete with mounting hardware!

For smooth, easy movement all curtain systems come complete with a heavy duty 16 gauge galvanized steel track and roller hook system.

Goff's unique Universal Track Splice allows for suspend, face, or flush mounting. Goff's will send you the proper assortment of hardware for your dimensions and layout.

*Floor Mount Hardware Also Available!* All hardware carries a limited lifetime warranty. For a complete list of hardware please visit [www.goffscurtainwalls.com/curtain-walls/curtain-wall-hardware](http://www.goffscurtainwalls.com/curtain-walls/curtain-wall-hardware)

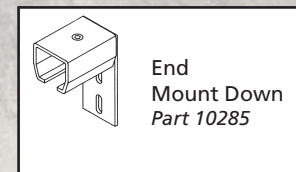
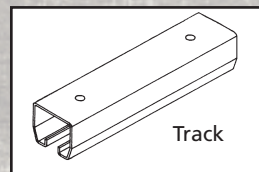
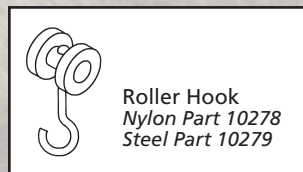
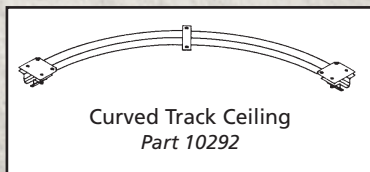
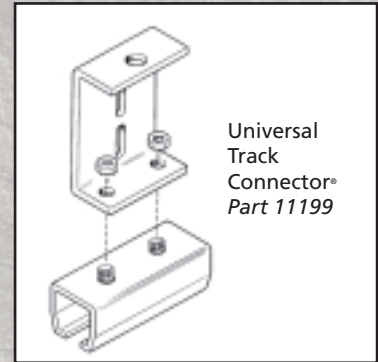

## Options & Accessories

### Goff's Curtain Walls can be equipped with a number of accessories and add-on's

**Floor Mount Wind Ties** – Easy to fasten tie downs are sewn directly onto the bottom of the Curtain. Available in 2 models.

**Filter Panels** – Easily removable and replaceable in 2 sizes: 2' x 4' or 4' x 4'. Filter sections are reinforced via a nylon scrim pattern.

**Strip Door** – 3' wide x 7' high replaceable strip door sewn directly into the curtain

**Valance Panels** – Stationary custom vinyl pieces manufactured to any size to seal area above the curtain. Perfect for slanted ceilings.

**Floor Sweep Attachment** – 6" replaceable vinyl piece to seal the gap between the Curtain Wall's bottom and the floor. Perfect for pitched floors.

**Curtain Wall Cleaner & Shield** – Shield All provides a semi-transparent, protective coating. Cleaner is a safe and effective way to clean the entire Curtain Wall without damaging the vinyl.

**Steel Rollers** – Recommended for curtains over 15' high

**Vinyl Mesh** – 11 oz 17x11 Mesh Scrim Available for improved airflow.

**Custom Logos** – Personalize your curtain with your company logo or slogan. Custom priced based on size, colors and quantity.

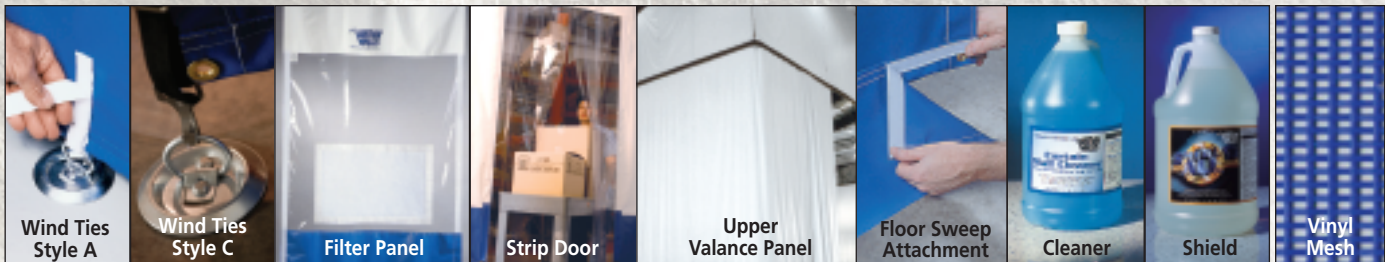

• Custom Curtain Walls • Custom Curtain Walls • Custom Curtain Walls • Custom Curtain Walls •



# Goff's SOUND CURTAINS

# Dependable Industrial Noise Control

## Contain & Absorb Harmful Industrial Strength Noises!



Collapsible Panels

### Benefits:

- Custom Made for Each Application
- Improves Working Conditions
- Durable & Sleek Panels
- Economical Alternative to Metal Enclosures

### Features:

- Collapsible Panels for Flexibility
- Reduction in Noise by up to 45 db
- Typical STC of 29 within Coverage Area
- High Mass Vinyl Barriers (No Lead)
- Sleek Design Minimizes Loss of Space
- Viscoelastic Acoustic Damper with Suspended Mineral Particles and an Aluminum Constraining Layer

*Unique Fan Fold Design Allows for Complete Flexibility in Sound Control!*

## Sound Control Curtains

Easily collapse and slide curtains out of the way when not needed. Operates on a track and roller system that can be flush, suspend, or face mounted. Panels connect with full length velcro.

Ideal for a wide variety of applications including large machinery, manufacturing area division, garages, and more!

### Options Available

- 7 Vinyl Colors Available
- Insulated Floor Sweep
- Acoustic Valance



## Sound Control Screens

Portable and versatile heavy duty 1-3/16" extruded aluminum frames allow for easy mobility. Panels can be joined together to form 2, 3, and 4 sided enclosures.

Ideal for a wide variety of applications including air compressors, small machinery, continuously moving noisy operations, and more!

### Options Available

- 7 Vinyl Colors Available
- Caster Kit for Easy Mobility
- Hinge Kit to Connect Adjacent Screens

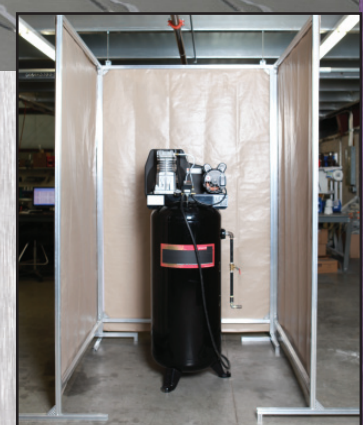

Sound Transmission Loss (db)							
Frequency	125	250	500	1000	2000	4000	STC
	12	16	25	32	38	45	29

  

Specifications	
Description	High Performance Sound Dampening Panels
Material	18 oz Solid Vinyl Exterior & Viscoelastic Acoustic Damper
Width	Specify (Each panel is 60" wide)
Height	Specify
Weight	0.6 lb/sq ft
Collapsing Width	+/- 10%
Grommets	#2 on 12" centers
Panel Joining	Full Length Velcro
Colors	Beige, Black, Blue, Gray, Green, Orange, Red, Yellow, & White
Mounting	Track & Roller System, Wall Mount or Free Standing Frame
Options	Floor Sweep, Caster Kit (Screens Only), Hinge Kit (Screens Only)

## Air Compressor Portable Acoustic Screens

Designed for 5-10 HP Vertical & Horizontal Piston Driven Reciprocating Compressors

There is a 4" gap from the bottom of curtain to the floor to allow air to flow through.  
There is a 7" gap from the bottom of the curtain to the floor on screens with casters.

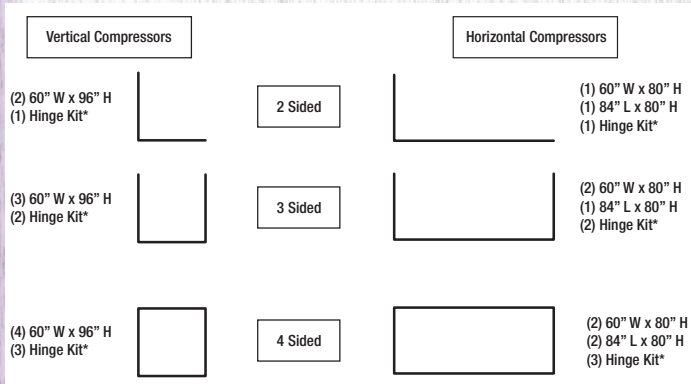

\* Note: Hinge Kits are available as an accessory.

Sides	Compressor	Enclosure Size
2	Vertical	60"W x 54"L x 96"H
3	Vertical	60"W x 54"L x 96"H
4	Vertical	60"W x 54"L x 96"H
2	Horizontal	60"W x 84"L x 80"H
3	Horizontal	60"W x 84"L x 80"H
4	Horizontal	60"W x 84"L x 80"H

**Warranty:** Goff's Enterprises, Inc. warrants all Curtain Wall Systems from failure in normal use due to defect in material or workmanship for a period of five years from date of purchase. Lifetime warranty on all track & roller hardware. Goff's Enterprises, Inc. may elect to repair or replace defective or damaged goods.



**Goff's Product line includes a variety of custom made vinyl products.**

Other products include High Performance Vinyl & Mesh Doors, Roll-up Curtains, Outdoor & Super Exterior Curtains, Climate Control Curtains, Welding Curtains, Strip Doors, Welding Screens, Privacy Screens, Noise Control Curtains & Screens, Trailer Doors, Manual Bug Blocking Doors, Food Processing Curtains, & More!

**Distributed By**

1/12



700 Hickory Street • Pewaukee, WI 53072  
Phone: (262) 691-4998 • 800-234-0337  
Fax: (262) 691-3255 • 800-959-0170  
www.GoffsCurtainWalls.com  
sales@goffscw.com  
Facebook.com/GoffsEnterprises  
Twitter.com/GoffsEnt



Made in U.S.A.



# Stock Curtains

*Separate & Maximize Your Usable Space!*



- ✓ Contain Overspray
- ✓ Reduce Rework
- ✓ Control Dust, Dirt, & Debris
- ✓ Create a Safe Work Environment
- ✓ Control Temperature
- ✓ Improve Working Conditions
- ✓ Eliminate Costly Permanent Walls
- ✓ Easy to Install
- ✓ Separate Conflicting Tasks

## Applications Include:

- Auto Body Shops
- Woodworking Facilities
- Industrial Separation
- Warehouses
- Home Enthusiasts
- And More!

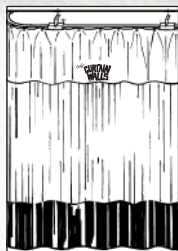
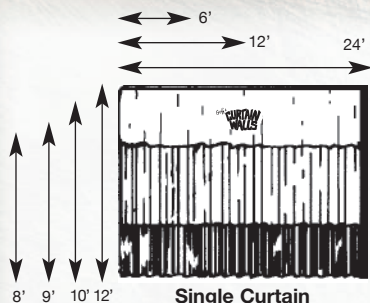

Single Curtain

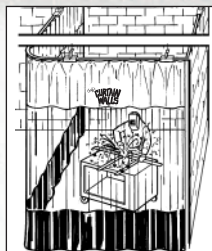

Two-Sided Station



Three-Sided Station

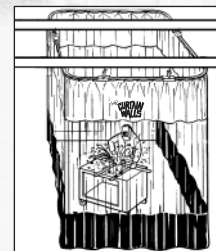

Four-Sided Station

**Stock Curtains** come in 6', 12' or 24' widths at 8', 9', 10', or 12' high. **Stock Curtain Stations** are available in 2, 3, or 4 sided layouts and are 24' long by 12' wide at 8', 9', 10' or 12' high.



**Stock Curtains Ship within 24 Hours!**





**The Flexible,  
Economical Solution  
to a Permanent Wall!**

- ✓ **Eliminate Rework**
- ✓ **Contain Saw Dust**
- ✓ **Contain Overspray**
- ✓ **Maximize Space**
- ✓ **Control Temperature**



**COST EFFECTIVE:**

Curtains are nearly 1/3 the cost of a permanent wall!

**FLEXIBLE:**

Rolls out of the way on a track and roller system.

**DURABLE:**

Fire proof, water proof, mildew and rot resistant.



*Goff's Curtain Walls create a cleaner, safer work environment and increase productivity by enabling workshops to MAXIMIZE usable space!*

## Materials & Construction

Goff's Original Curtain Walls are constructed with a combination of some of the finest industrial vinyls available. The upper and lower opaque, PVC sections are 14 oz. per square yard, reinforced with a polyester 9 x 9 x 1300 denier weft inserted scrim which is laminated into the fabric to give the curtain a high tear and tensile strength without sacrificing flexibility. Curtains are flame retardant meeting NFPA 701 and California State Fire Marshall Standard.

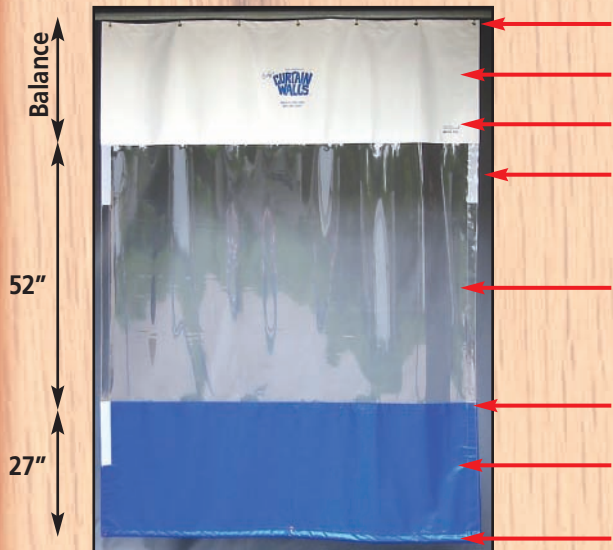

- #2 Brass Tooth Grommets on 1' Centers
- 14 oz. Reinforced Vinyl White Top Section
- All Seams Double Lock Stitched
- Hook & Loop Fasteners Allow Adjacent Panels To Be Easily Attached To One Another
- 20 mil. Double Polished Clear Window Section
- All Sections Joined Together Using Mildew/Rot Resistant Thread
- 14 oz. Reinforced Colored Vinyl Section (your choice of over 12 different colors)
- Chain Weighted Lower Hem

### Accessories



### Vinyl Color Options – Available with or without clear window!

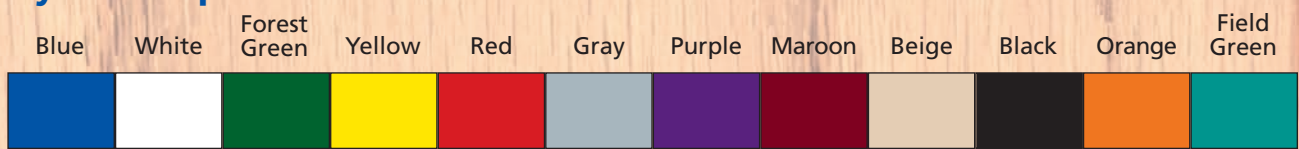

### Goff's Other Products

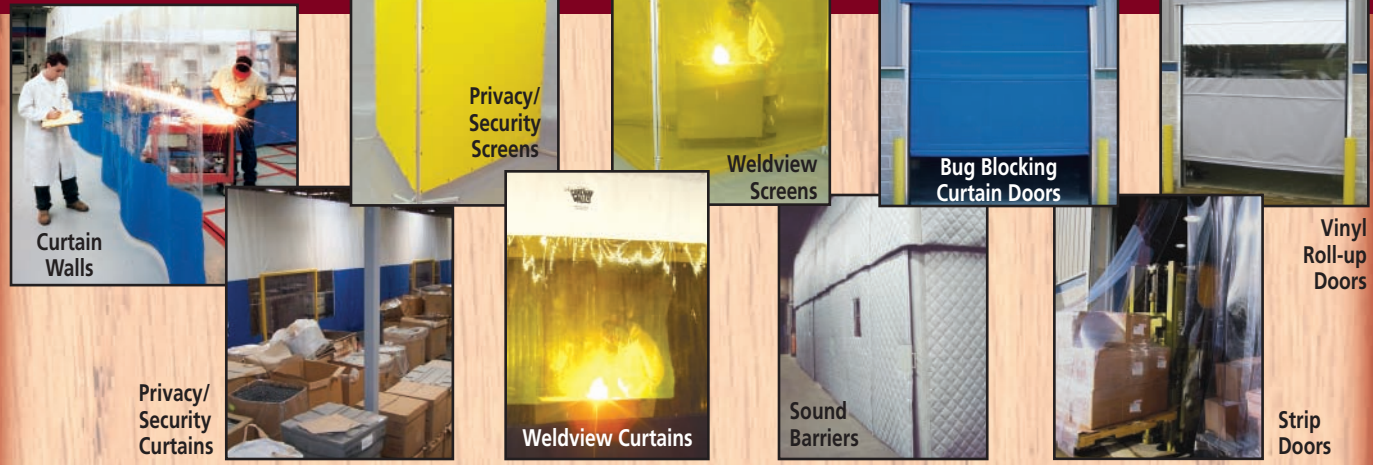

Distributed By

Goff's Enterprises, Inc., 1228 Hickory Street, Pewaukee, WI 53072  
 E-mail: sales@goffscw.com • www.goffscurtainwalls.com  
 Phone: (262) 691-4998 • 800-234-0337; Fax (262) 691-3255 • 800-959-0170





• AUTOBODY • INDUSTRIAL • COMMERCIAL • FOOD SERVICE • RESIDENTIAL •

• AUTOBODY • INDUSTRIAL • COMMERCIAL • FOOD SERVICE • RESIDENTIAL •



# MANUAL & MOTORIZED ROLL-UP CURTAINS

From the Makers of

The Original

Goff's  
**CURTAIN  
WALLS**



## OPEN UP FLOOR SPACE

### Ideal For:

- Prep Area Separation
- Shop Dividers
- Wash Bays
- Factory Dividers
- Room Dividers
- Patios

**Roll-up curtains  
stay cleaner longer.**



### Features

- 14 or 18 oz Reinforced Top Section
- All Seams Doubled Lock Stitched
- 20 or 40 mil Double Polished Clear Window Section
- All Sections Joined Together Using Mildew/Rot Resistant Thread
- Fiberglass Pultrusion Tube And Lower Chain Weighted Hem

**Maximize floor space by rolling them up out of the way when not in use.**

## INDOOR AND OUTDOOR APPLICATIONS

Goff's Original Curtain Walls are constructed with a combination of some of the finest industrial vinyls available. The upper and lower opaque, PVC sections are 14 oz. per square yard, reinforced with a polyester 9 x 9 x 1300 denier weft inserted scrim which is laminated into the fabric to give the curtain a high tear and tensile strength without sacrificing flexibility.

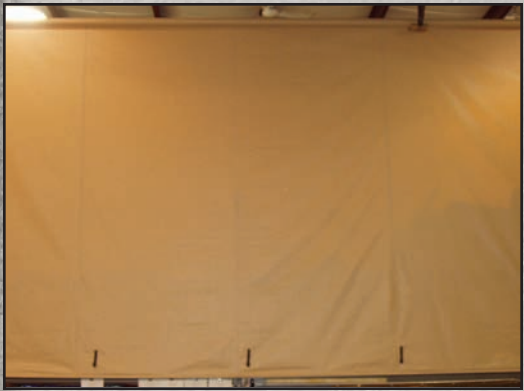

### Features:

- Meets NFPA-701 Tests for Fire Resistance (required law for "Limited Finishing Stations") as well as the California State Fire Marshal Standard (14oz. only)
- Water Repellent, Mildew & Rot Resistant
- Resistant to Most Chemicals
- Withstands Continuous Temperature to 180°F
- Cold Crack Resistance to -4°F
- 12 Standard Colors in Stock

### In Tube Motor

- 6"/sec. 40% duty cycle
- 500 cycles per day
- 110-Volt Operation

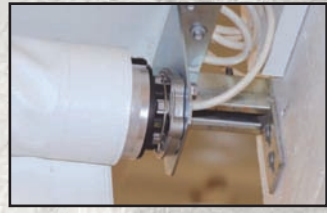

### Options:

- Floor Mounted Wind Ties
- Valances

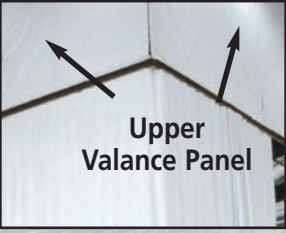

**Manual Handcrank Roll-Up Curtains**  
 Roll up easily with an awning hand crank. Removable for storage.

### Operation:

Toggle Switch, Push Button or RF Operation



3 Position Toggle Switch (Standard)



Handheld Remote Control



Nema 1 (Interior Use) Hard Wired Control



Nema 4 Wireless, (Indoor/Outdoor) Wall Mounted Control (or with Locking Control-not shown)

### Goff's Other Products

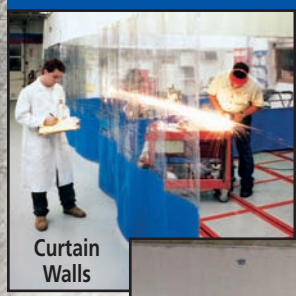

Curtain Walls



Privacy/Security Screens



Weldview Screens



Bug Blocking Curtain Doors



Vinyl Roll-Up Door

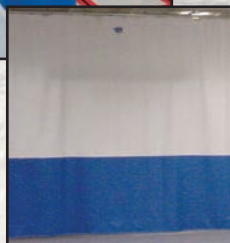

Privacy/Security Curtains



Weldview Curtains



Sound Barriers



Strip Doors

Distributed By



Goff's Enterprises, Inc., 1228 Hickory Street, Pewaukee, WI 53072  
 e-mail: sales@goffscw.com • www.goffscurtainwalls.com  
 Phone (262) 691-4998 • 800-234-0337; Fax (262) 691-3255 • 800-959-0170  
 11.07 Copyright © 2007 Goff's Enterprises, Inc.